

LHF Box Corner Top View

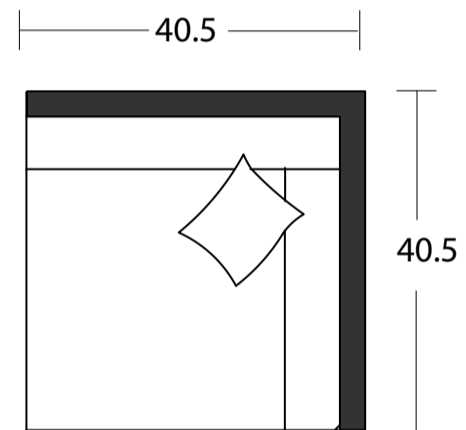

RHF Box Corner Top View

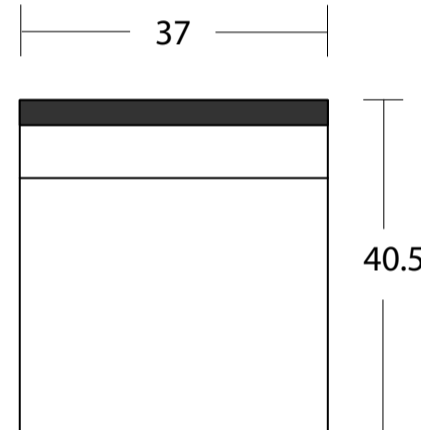

Armless Chair Top View

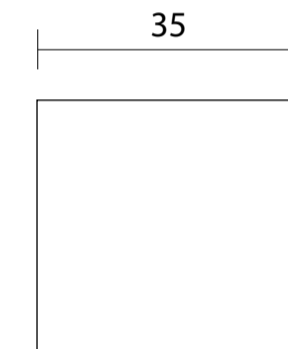

Ottoman 35 Top View

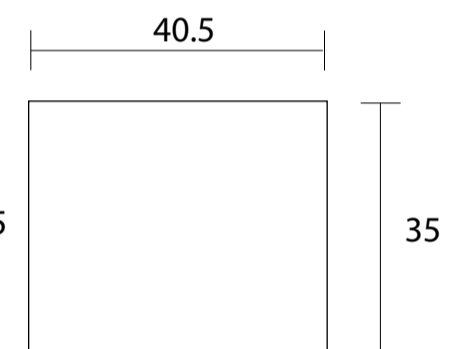

Ottoman 40 Top View

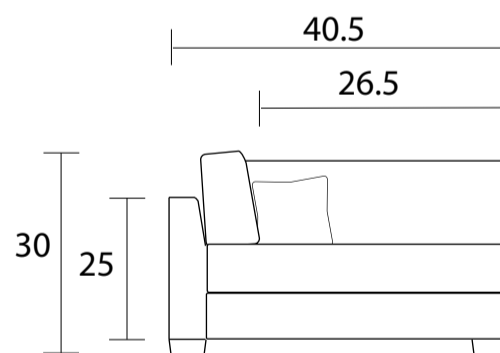

LHF Box Corner

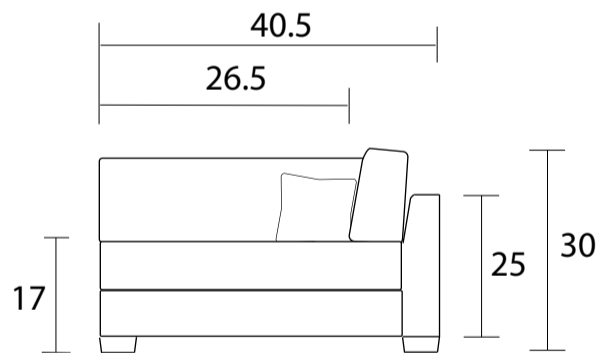

RHF Box Corner

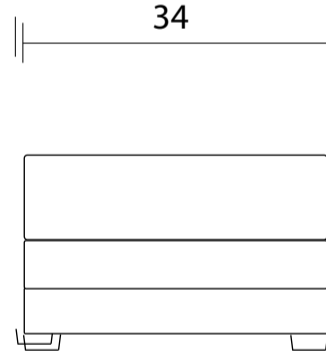

Armless Chair

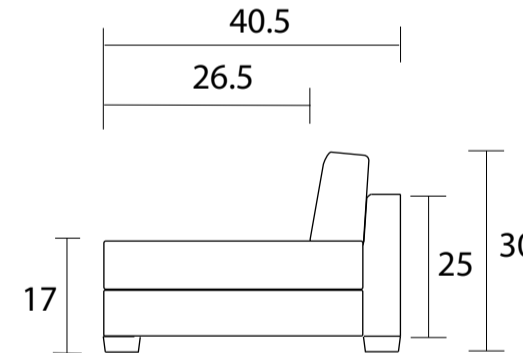

Armless Chair Sideview

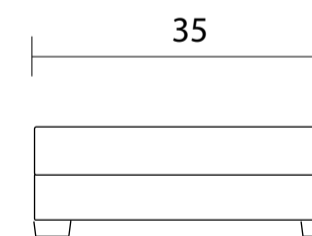

Ottoman 35

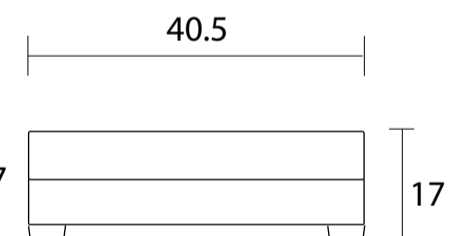

Ottoman 40

Specifications:

- 2" square tapered leg, espresso. Also available in walnut, please specify on order
- 1 knife edge toss pillow (19" x 19") with zipper, accented up to grade G (per corner)
- No-Sag sinuous spring system with loose seat cushion
- Loose wrapped back cushion
- Schematic page should accompany order for sectional clip placement
- Not available in leather
- Measurements may vary +/- 1"
- February, 10th. 2022

COM Requirement	Yards
Box Corner	9
Armless Chair	6.5
Ottoman 40	4
Ottoman 35	4

Yardage indicated is based on 54" solid, railroaded, non-matched fabrics